

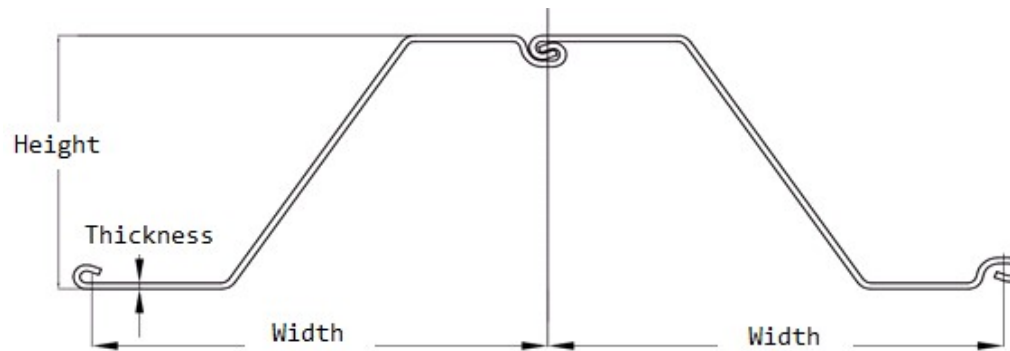

SLZ 18-700 (Cold rolled sheet piles)



Section description	Product group	Shape	Section Modulus	Moment of Inertia	Width	Height	Thickness		Weight single	Weight	Coating 2 sides	Coating area
			in ³ /ft cm ³ /m	in ⁴ /ft cm ⁴ /m	inch mm	inch mm	inch mm	inch mm				
SLZ 18-700	Cold rolled sheet piles	Z	33.6	278.2	27.56	16.54	0.354	0.354	51.4	22.39	6.73	1.47
			1,808	37,990	700	420	9.0	9.0	76.50	33.32	2.06	1.47

Production acc. ASTM standards or EN10249 1&2 in varies steel grades

Origin: USA

Datasheet for estimation and comparison purposes

Exclusive by Meever USA