

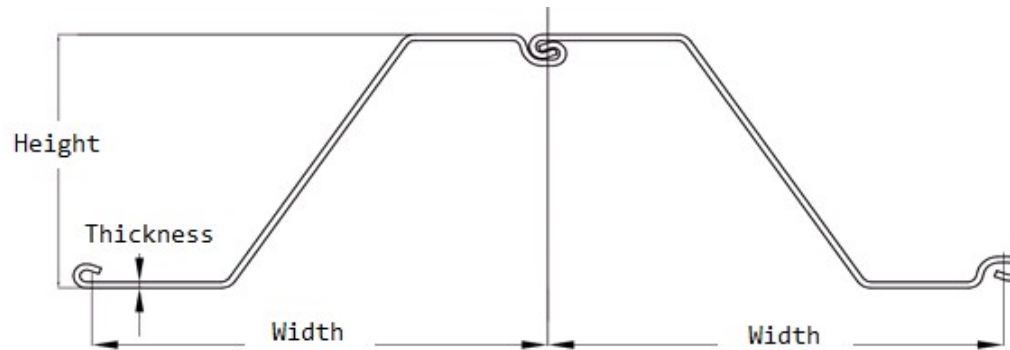

SLZ 18-850 (Cold rolled sheet piles)



Section description	Product group	Shape	Section Modulus	Moment of Inertia	Width	Height	Thickness		Weight single	Weight	Coating 2 sides	Coating area
			in ³ /ft cm ³ /m	in ⁴ /ft cm ⁴ /m	inch mm	inch mm	inch mm	inch mm				
SLZ 18-850	Cold rolled sheet piles	Z	35.4	328.0	33.46	18.50	0.375	0.375	60.9	21.83	7.55	1.36
			1,905	44,796	850	470	9.5	9.5	90.60	32.48	2.31	1.36

Production acc. ASTM standards or EN10249 1&2 in varies steel grades

Origin: USA

Datasheet for estimation and comparison purposes

Exclusive by Meever USA