

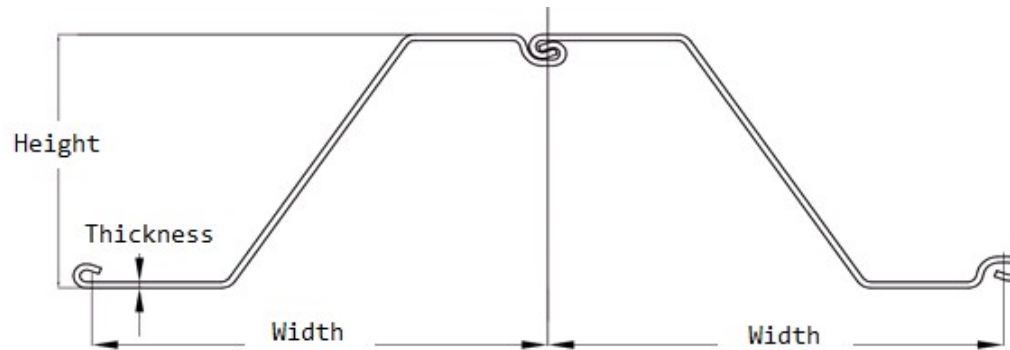

SLZ 19-700 (Cold rolled sheet piles)



Section description	Product group	Shape	Section Modulus	Moment of Inertia	Width	Height	Thickness		Weight single	Weight	Coating 2 sides	Coating area
			in ³ /ft cm ³ /m	in ⁴ /ft cm ⁴ /m	inch mm	inch mm	inch mm	inch mm				
SLZ 19-700	Cold rolled sheet piles	Z	35.0	289.9	27.56	16.57	0.375	0.375	53.8	23.41	6.67	1.46
			1,880	39,592	700	421	9.5	9.5	79.99	34.83	2.04	1.46

Production acc. ASTM standards or EN10249 1&2 in varies steel grades

Origin: USA

Datasheet for estimation and comparison purposes

Exclusive by Meever USA