

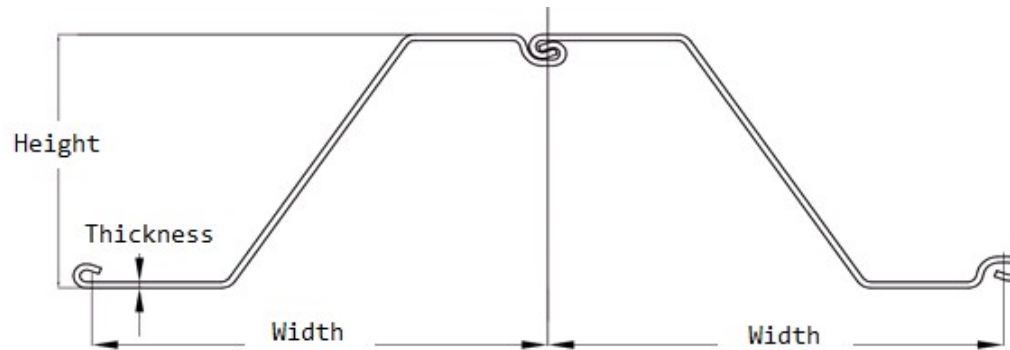

SLZ 22-724 (Cold rolled sheet piles)



Section description	Product group	Shape	Section Modulus	Moment of Inertia	Width	Height	Thickness		Weight single	Weight	Coating 2 sides	Coating area
			in ³ /ft cm ³ /m	in ⁴ /ft cm ⁴ /m	inch mm	inch mm	inch mm	inch mm				
SLZ 22-724	Cold rolled sheet piles	Z	33.2	300.6	28.50	18.11	0.335	0.335	49.9	21.02	6.92	1.46
			1,784	41,047	724	460	8.5	8.5	74.30	31.28	2.11	1.46

Production acc. ASTM standards or EN10249 1&2 in varies steel grades

Origin: USA

Datasheet for estimation and comparison purposes

Exclusive by Meever USA