

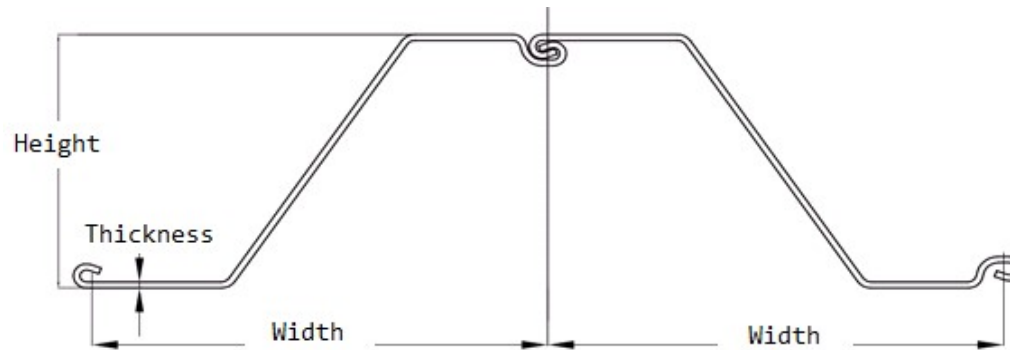

SLZ 33-700 (Cold rolled sheet piles)



Section description	Product group	Shape	Section Modulus	Moment of Inertia	Width	Height	Thickness		Weight single	Weight	Coating 2 sides	Coating area
			in ³ /ft cm ³ /m	in ⁴ /ft cm ⁴ /m	inch mm	inch mm	inch mm	inch mm				
SLZ 33-700	Cold rolled sheet piles	Z	59.7	587.2	27.56	19.69	0.472	0.472	76.8	33.42	7.54	1.65
			3,207	80,181	700	500	12.0	12.0	114.20	49.73	2.30	1.65

Production acc. ASTM standards or EN10249 1&2 in varies steel grades

Origin: USA

Datasheet for estimation and comparison purposes

Exclusive by Meever USA