

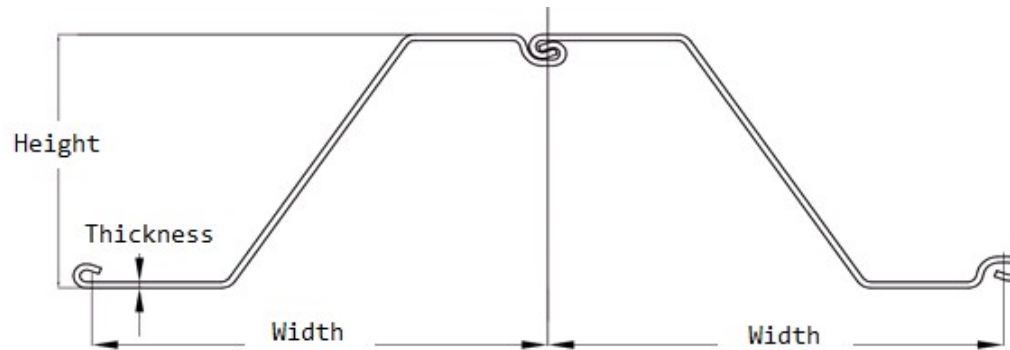

SLZ 38-800 (Cold rolled sheet piles)



Section description	Product group	Shape	Section Modulus	Moment of Inertia	Width	Height	Thickness		Weight single	Weight	Coating 2 sides	Coating area
			in ³ /ft cm ³ /m	in ⁴ /ft cm ⁴ /m	inch mm	inch mm	inch mm	inch mm				
SLZ 38-800	Cold rolled sheet piles	Z	72.2	852.8	31.50	23.62	0.512	0.512	92.1	35.10	8.35	1.60
			3,881	116,458	800	600	13.0	13.0	137.10	52.23	2.55	1.60

Production acc. ASTM standards or EN10249 1&2 in varies steel grades

Origin: USA

Datasheet for estimation and comparison purposes

Exclusive by Meever USA