

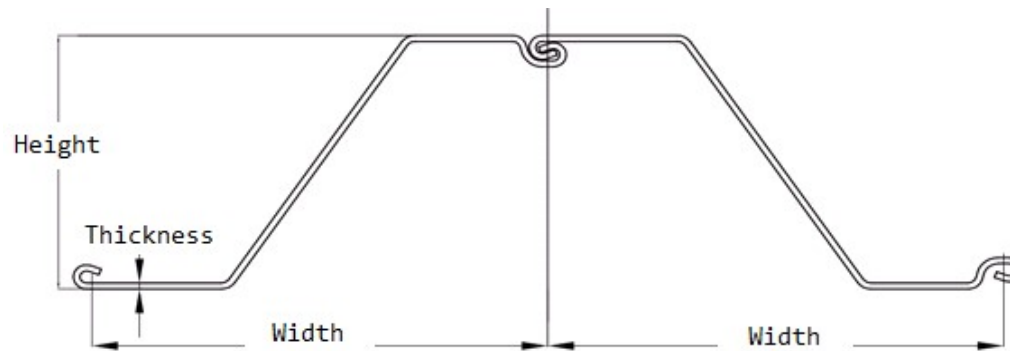

SLZ 7-850 (Cold rolled sheet piles)



Section description	Product group	Shape	Section Modulus	Moment of Inertia	Width	Height	Thickness		Weight single	Weight	Coating 2 sides	Coating area
			in ³ /ft cm ³ /m	in ⁴ /ft cm ⁴ /m	inch mm	inch mm	inch mm	inch mm				
SLZ 7-850	Cold rolled sheet piles	Z	13.7	91.9	33.46	13.39	0.236	0.236	34.5	12.36	6.77	1.22
			738	12,551	850	340	6.0	6.0	51.31	18.39	2.07	1.22

Production acc. ASTM standards or EN10249 1&2 in varies steel grades

Origin: USA

Datasheet for estimation and comparison purposes

Exclusive by Meever USA