

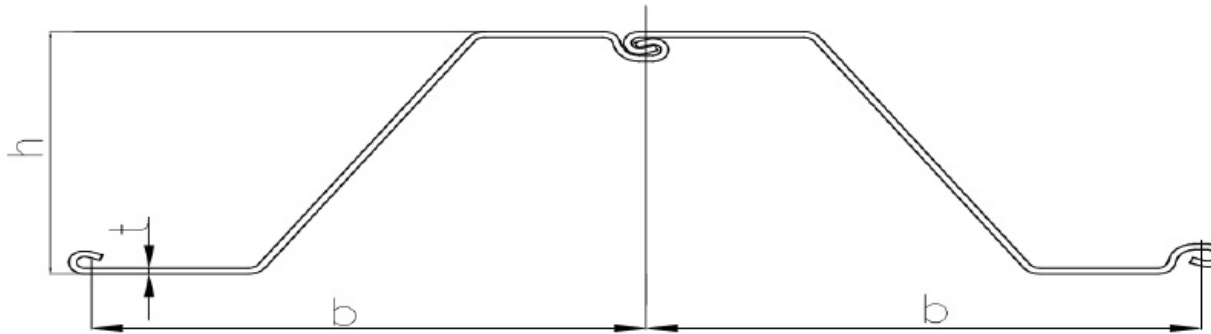

SCZ 14 (Cold rolled sheet piles)



Section description	Product group	Shape	Section Modulus	Moment of Inertia	Width	Height	Thickness flange	Thickness web	Weight single	Weight	Coating 2 sides	Coating area
			in ³ /ft cm ³ /m	in ⁴ /ft cm ⁴ /m	inch mm	inch mm	inch mm	inch mm	lbs/ft kg/m	lbs/ft ² kg/m ²	ft ² /ft m ² /m	ft ² /ft m ² /m
SCZ 14	Cold rolled sheet piles	Z	14.4	71.8	28.50	10.00	0.250	0.250	33.8	14.24	6.10	1.28
			772	9,808	724	254	6.4	6.4	50.31	21.19	1.86	1.28

Production acc. ASTM standards or EN10249 1&2 in varies steel grades

Origin: USA

Datasheet for estimation and comparison purposes