

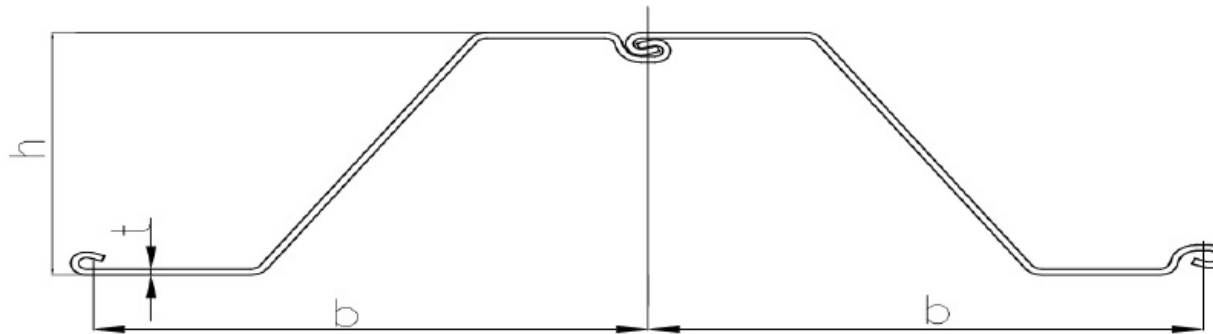

SKZ 22 (Cold rolled sheet piles)



Section description	Product group	Shape	Section Modulus	Moment of Inertia	Width	Height	Thickness flange	Thickness web	Weight single	Weight	Coating 2 sides	Coating area
			in ³ /ft cm ³ /m	in ⁴ /ft cm ⁴ /m	inch mm	inch mm	inch mm	inch mm	lbs/ft kg/m	lbs/ft ² kg/m ²	ft ² /ft m ² /m	ft ² /ft m ² /m
SKZ 22	Cold rolled sheet piles	Z	33.4	267.4	28.50	16.00	0.335	0.335	51.3	21.60	7.60	1.60
			1,797	36,516	724	406	8.5	8.5	76.33	32.14	2.32	1.60

Production acc. ASTM standards or EN10249 1&2 in varies steel grades

Origin: USA

Datasheet for estimation and comparison purposes