

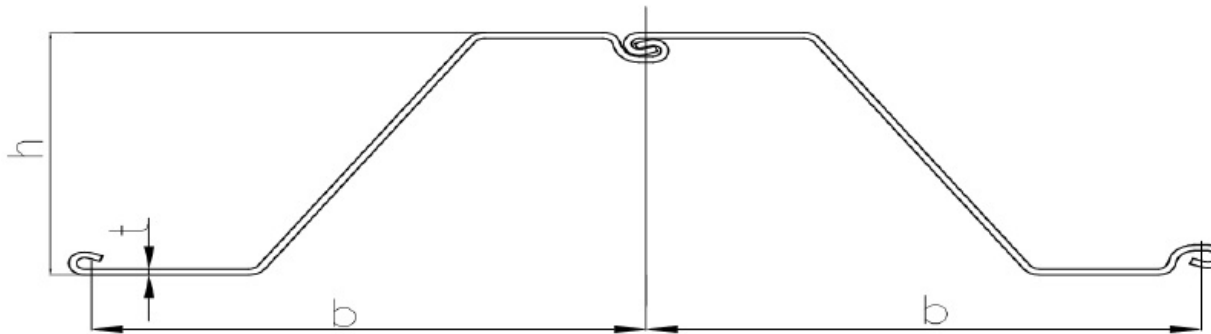

SKZ 25 (Cold rolled sheet piles)



Section description	Product group	Shape	Section Modulus	Moment of Inertia	Width	Height	Thickness flange	Thickness web	Weight single	Weight	Coating 2 sides	Coating area
			in ³ /ft cm ³ /m	in ⁴ /ft cm ⁴ /m	inch mm	inch mm	inch mm	inch mm	lbs/ft kg/m	lbs/ft ² kg/m ²	ft ² /ft m ² /m	ft ² /ft m ² /m
SKZ 25	Cold rolled sheet piles	Z	40.1	321.1	28.50	16.00	0.399	0.399	61.1	25.73	7.60	1.60
			2,158	43,852	724	406	10.1	10.1	90.92	38.29	2.32	1.60

Production acc. ASTM standards or EN10249 1&2 in varies steel grades

Origin: USA

Datasheet for estimation and comparison purposes