

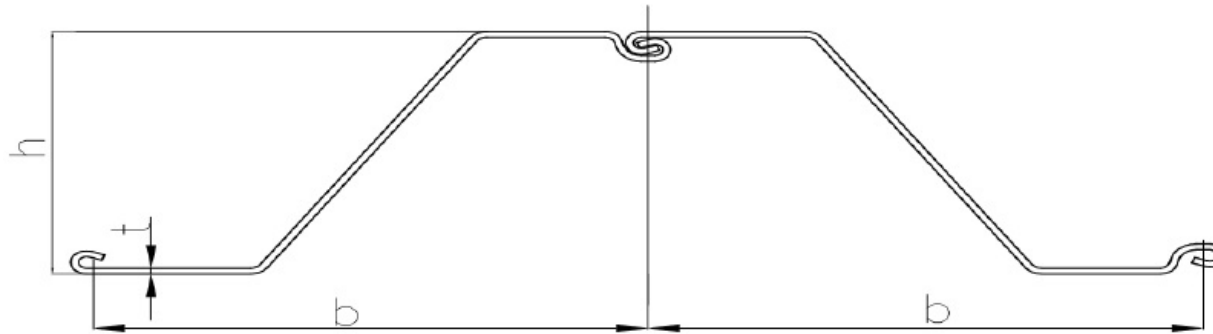

SKZ 34 (Cold rolled sheet piles)



Section description	Product group	Shape	Section Modulus	Moment of Inertia	Width	Height	Thickness flange	Thickness web	Weight single	Weight	Coating 2 sides	Coating area
			in ³ /ft cm ³ /m	in ⁴ /ft cm ⁴ /m	inch mm	inch mm	inch mm	inch mm	lbs/ft kg/m	lbs/ft ² kg/m ²	ft ² /ft m ² /m	ft ² /ft m ² /m
SKZ 34	Cold rolled sheet piles	Z	57.6	518.6	28.50	18.00	0.500	0.500	81.4	34.28	8.06	1.70
			3,098	70,822	724	457	12.7	12.7	121.15	51.01	2.46	1.70

Production acc. ASTM standards or EN10249 1&2 in varies steel grades

Origin: USA

Datasheet for estimation and comparison purposes