

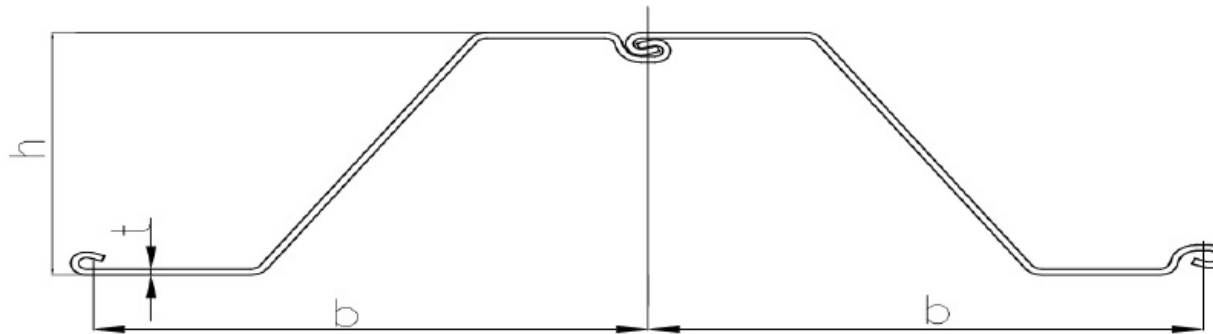

SKZ 38 (Cold rolled sheet piles)



Section description	Product group	Shape	Section Modulus	Moment of Inertia	Width	Height	Thickness flange	Thickness web	Weight single	Weight	Coating 2 sides	Coating area
			in ³ /ft cm ³ /m	in ⁴ /ft cm ⁴ /m	inch mm	inch mm	inch mm	inch mm	lbs/ft kg/m	lbs/ft ² kg/m ²	ft ² /ft m ² /m	ft ² /ft m ² /m
SKZ 38	Cold rolled sheet piles	Z	62.3	560.9	28.50	18.00	0.550	0.550	89.0	37.45	8.06	1.70
			3,351	76,589	724	457	14.0	14.0	132.36	55.73	2.46	1.70

Production acc. ASTM standards or EN10249 1&2 in varies steel grades

Origin: USA

Datasheet for estimation and comparison purposes