

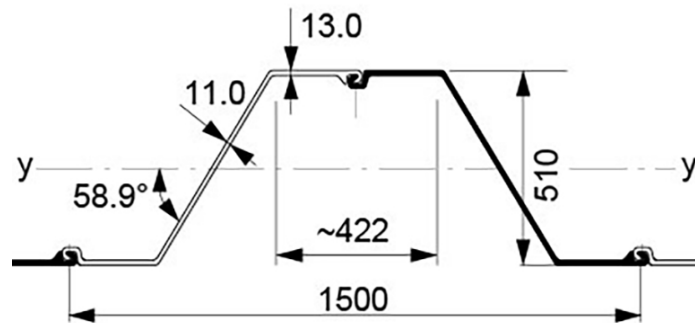

AZ 30-750 (Hot rolled sheet piles)



Section description	Product group	Shape	Section Modulus	Moment of Inertia	Width	Height	Thickness flange	Thickness web	Weight single	Weight	Coating 2 sides	Coating area
			in ³ /ft cm ³ /m	in ⁴ /ft cm ⁴ /m	inch mm	inch mm	inch mm	inch mm	lbs/ft kg/m	lbs/ft ² kg/m ²	ft ² /ft m ² /m	ft ² /ft m ² /m
AZ 30-750	Hot rolled sheet piles	Z	55.9	561.5	29.53	20.08	0.512	0.433	73.1	29.70	6.93	1.41
			3,005	76,677	750	510	13.0	11.0	108.74	44.19	2.12	1.41

Production acc. EN10248 1&2 in varies steel grades
Origin: Luxembourg
Datasheet for estimation and comparison purposes