

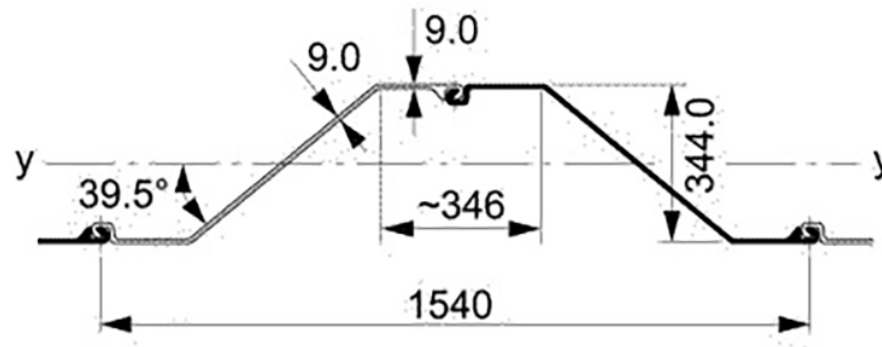

AZ13-770 (Hot rolled sheet piles)



Section description	Product group	Shape	Section Modulus	Moment of Inertia	Width	Height	Thickness flange	Thickness web	Weight single	Weight	Coating 2 sides	Coating area
			in ³ /ft cm ³ /m	in ⁴ /ft cm ⁴ /m	inch mm	inch mm	inch mm	inch mm	lbs/ft kg/m	lbs/ft ² kg/m ²	ft ² /ft m ² /m	ft ² /ft m ² /m
AZ13-770	Hot rolled sheet piles	Z	24.2	163.7	30.31	13.54	0.354	0.354	51.1	20.25	6.07	1.20
			1,301	22,355	770	344	9.0	9.0	76.10	30.13	1.85	1.20

Production acc. EN10248 1&2 in varies steel grades
Origin: Luxembourg
Datasheet for estimation and comparison purposes