

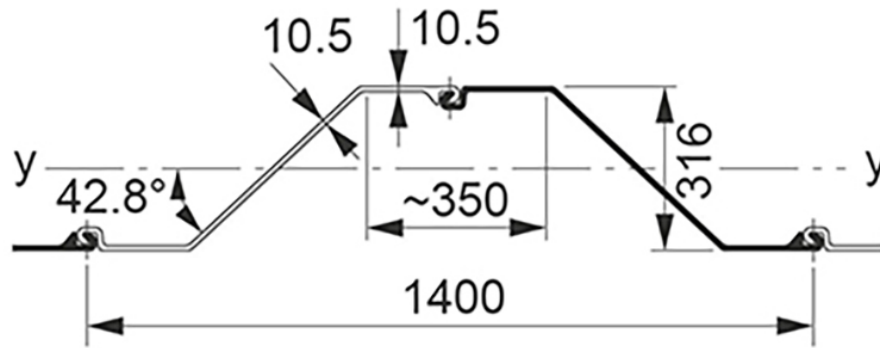

## AZ14-700 (Hot rolled sheet piles)



Section description	Product group	Shape	Section Modulus	Moment of Inertia	Width	Height	Thickness flange	Thickness web	Weight single	Weight	Coating 2 sides	Coating area
			in <sup>3</sup> /ft cm <sup>3</sup> /m	in <sup>4</sup> /ft cm <sup>4</sup> /m	inch mm	inch mm	inch mm	inch mm	lbs/ft kg/m	lbs/ft <sup>2</sup> kg/m <sup>2</sup>	ft <sup>2</sup> /ft m <sup>2</sup> /m	ft <sup>2</sup> /ft m <sup>2</sup> /m
AZ14-700	Hot rolled sheet piles	Z	26.1	162.5	27.56	12.44	0.413	0.413	54.0	23.49	5.59	1.22
			1,403	22,191	700	316	10.5	10.5	80.29	34.95	1.71	1.22

Production acc. EN10248 1&2 in varies steel grades  
 Origin: Luxembourg  
 Datasheet for estimation and comparison purposes