

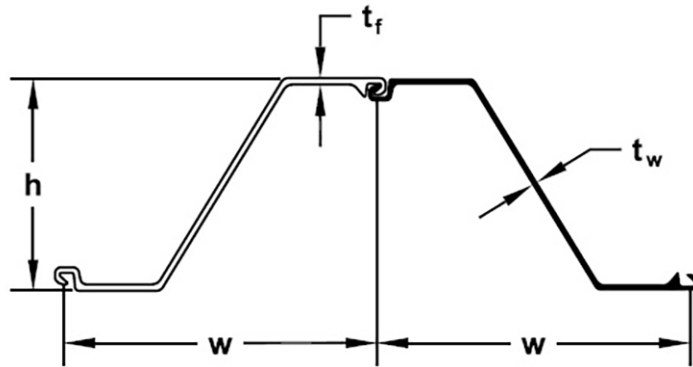

AZ17 (Hot rolled sheet piles)



Section description	Product group	Shape	Section Modulus	Moment of Inertia	Width	Height	Thickness flange	Thickness web	Weight single	Weight	Coating 2 sides	Coating area
			in ³ /ft cm ³ /m	in ⁴ /ft cm ⁴ /m	inch mm	inch mm	inch mm	inch mm	lbs/ft kg/m	lbs/ft ² kg/m ²	ft ² /ft m ² /m	ft ² /ft m ² /m
AZ17	Hot rolled sheet piles	Z	31.0	231.3	24.80	14.92	0.335	0.335	46.0	22.24	5.63	1.37
			1,665	31,580	630	379	8.5	8.5	68.40	33.09	1.72	1.37

Production acc. EN10248 1&2 in varies steel grades
 Origin: Luxembourg
 Datasheet for estimation and comparison purposes