

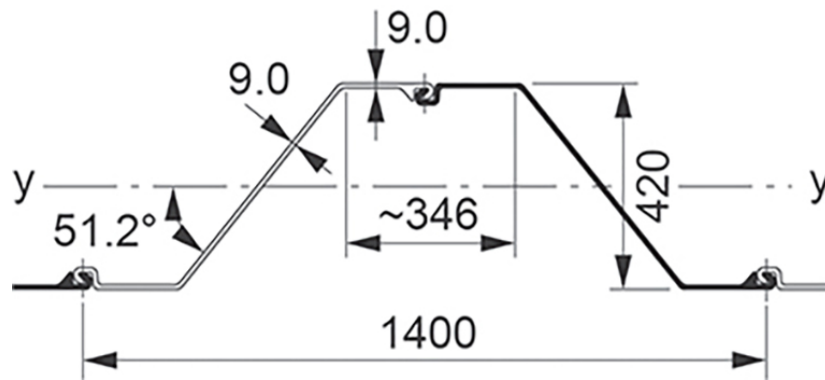

AZ18-700 (Hot rolled sheet piles)



Section description	Product group	Shape	Section Modulus	Moment of Inertia	Width	Height	Thickness flange	Thickness web	Weight single	Weight	Coating 2 sides	Coating area
			in ³ /ft cm ³ /m	in ⁴ /ft cm ⁴ /m	inch mm	inch mm	inch mm	inch mm	lbs/ft kg/m	lbs/ft ² kg/m ²	ft ² /ft m ² /m	ft ² /ft m ² /m
AZ18-700	Hot rolled sheet piles	Z	33.5	276.8	27.56	16.54	0.354	0.354	51.4	22.38	6.10	1.33
			1,801	37,799	700	420	9.0	9.0	76.50	33.30	1.86	1.33

Production acc. EN10248 1&2 in varies steel grades
 Origin: Luxembourg
 Datasheet for estimation and comparison purposes