

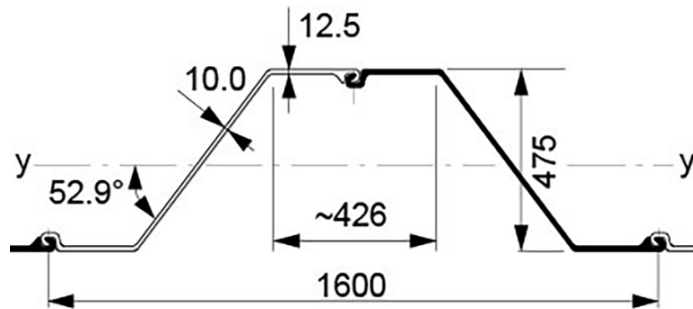

AZ25-800 (Hot rolled sheet piles)



Section description	Product group	Shape	Section Modulus	Moment of Inertia	Width	Height	Thickness flange	Thickness web	Weight single	Weight	Coating 2 sides	Coating area
			in ³ /ft cm ³ /m	in ⁴ /ft cm ⁴ /m	inch mm	inch mm	inch mm	inch mm	lbs/ft kg/m	lbs/ft ² kg/m ²	ft ² /ft m ² /m	ft ² /ft m ² /m
AZ25-800	Hot rolled sheet piles	Z	53.8	435.1	31.50	18.70	0.492	0.394	68.9	26.26	6.94	1.32
			2,892	59,416	800	475	12.5	10.0	102.54	39.07	2.12	1.32

Production acc. EN10248 1&2 in varies steel grades
Origin: Luxembourg
Datasheet for estimation and comparison purposes