

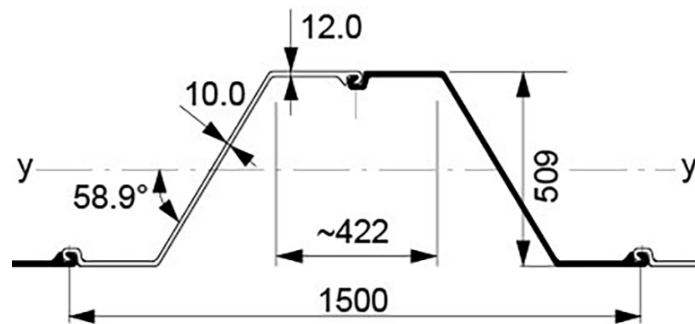

## AZ28-750 (Hot rolled sheet piles)



Section description	Product group	Shape	Section Modulus	Moment of Inertia	Width	Height	Thickness flange	Thickness web	Weight single	Weight	Coating 2 sides	Coating area
			in <sup>3</sup> /ft cm <sup>3</sup> /m	in <sup>4</sup> /ft cm <sup>4</sup> /m	inch mm	inch mm	inch mm	inch mm	lbs/ft kg/m	lbs/ft <sup>2</sup> kg/m <sup>2</sup>	ft <sup>2</sup> /ft m <sup>2</sup> /m	ft <sup>2</sup> /ft m <sup>2</sup> /m
AZ28-750	Hot rolled sheet piles	Z	52.3	523.9	29.53	20.04	0.472	0.394	67.7	27.52	6.93	1.41
			2,812	71,543	750	509	12.0	10.0	100.78	40.95	2.12	1.41

Production acc. EN10248 1&2 in varies steel grades  
 Origin: Luxembourg  
 Datasheet for estimation and comparison purposes