

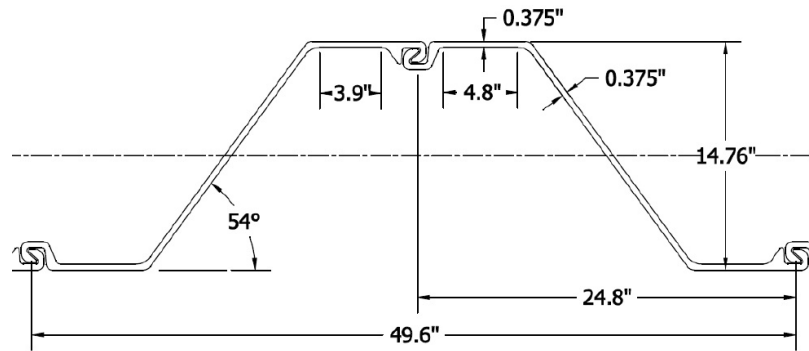

ESZ18-630 (Hot rolled sheet piles)



Section description	Product group	Shape	Section Modulus	Moment of Inertia	Width	Height	Thickness flange	Thickness web	Weight single	Weight	Coating 2 sides	Coating area
			in ³ /ft cm ³ /m	in ⁴ /ft cm ⁴ /m	inch mm	inch mm	inch mm	inch mm	lbs/ft kg/m	lbs/ft ² kg/m ²	ft ² /ft m ² /m	ft ² /ft m ² /m
ESZ18-630	Hot rolled sheet piles	Z	33.6	247.9	24.80	14.76	0.374	0.374	51.1	24.71	5.43	1.32
			1,805	33,850	630	375	9.5	9.5	76.01	36.77	1.66	1.32

Exclusive US Distributor

available for sale and rent
from stock and mill direct
Production acc. EN10248 1&2 in grades 50, 60, 65, A690
Origin: UAE