

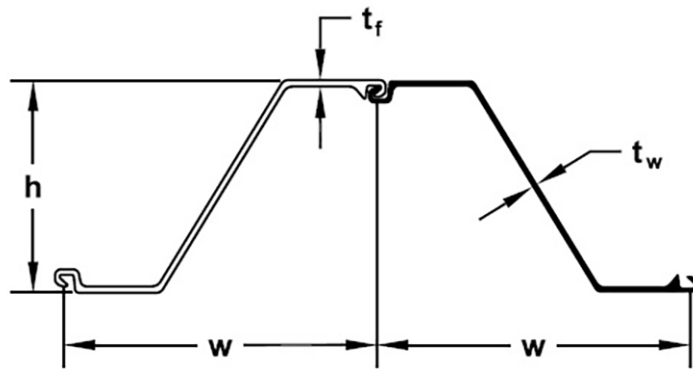

H3807 (Hot rolled sheet piles)



Section description	Product group	Shape	Section Modulus	Moment of Inertia	Width	Height	Thickness		Weight single	Weight	Coating 2 sides	Coating area
			in ³ /ft cm ³ /m	in ⁴ /ft cm ⁴ /m	inch mm	inch mm	inch mm	inch mm	lbs/ft kg/m	lbs/ft ² kg/m ²	ft ² /ft m ² /m	ft ² /ft m ² /m
H3807	Hot rolled sheet piles	Z	70.7	695.7	27.56	0.71	0.472	0.709	84.6	36.84	6.89	1.50
			3,801	95,003	700	18	12.0	18.0	125.88	54.82	2.11	1.50

Production discontinued

Production acc. ASTM standards or EN10248 1&2 in varies steel grades

Origin: Germany

Datasheet for estimation and comparison purposes