

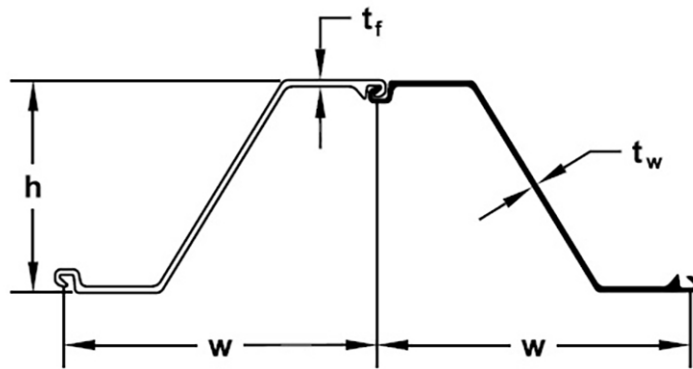

NZ14 (Hot rolled sheet piles)



Section description	Product group	Shape	Section Modulus	Moment of Inertia	Width	Height	Thickness flange	Thickness web	Weight single	Weight	Coating 2 sides	Coating area
			in ³ /ft cm ³ /m	in ⁴ /ft cm ⁴ /m	inch mm	inch mm	inch mm	inch mm	lbs/ft kg/m	lbs/ft ² kg/m ²	ft ² /ft m ² /m	ft ² /ft m ² /m
NZ14	Hot rolled sheet piles	Z	25.7	171.7	30.31	13.39	0.375	0.375	55.0	21.77	6.10	1.21
			1,379	23,447	770	340	9.5	9.5	81.84	32.39	1.86	1.21

Production acc. ASTM standard or EN10248 1&2 in varies steel grades

Origin: USA

Datasheet for estimation and comparison purposes