

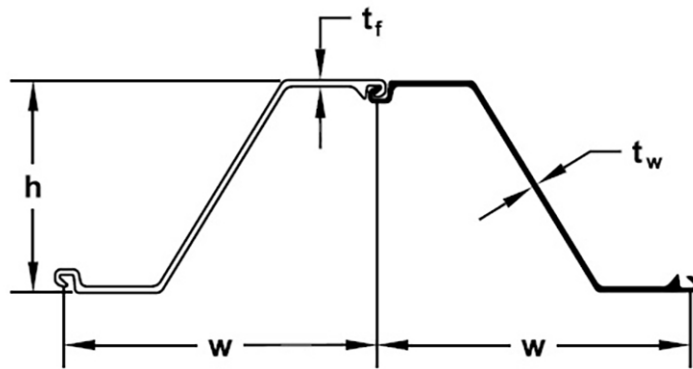

NZ20 (Hot rolled sheet piles)



Section description	Product group	Shape	Section Modulus	Moment of Inertia	Width	Height	Thickness flange	Thickness web	Weight single	Weight	Coating 2 sides	Coating area
			in ³ /ft cm ³ /m	in ⁴ /ft cm ⁴ /m	inch mm	inch mm	inch mm	inch mm	lbs/ft kg/m	lbs/ft ² kg/m ²	ft ² /ft m ² /m	ft ² /ft m ² /m
NZ20	Hot rolled sheet piles	Z	36.2	292.8	27.56	16.16	0.394	0.394	57.0	24.82	6.15	1.34
			1,948	39,984	700	410	10.0	10.0	84.83	36.93	1.88	1.34

Production acc. ASTM standard or EN10248 1&2 in varies steel grades

Origin: USA

Datasheet for estimation and comparison purposes