

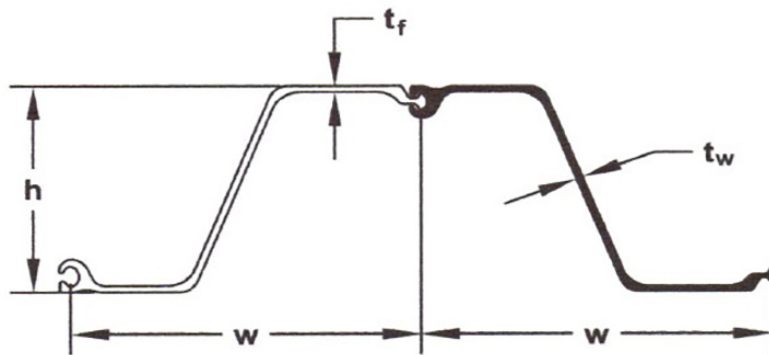

PZ27 (Hot rolled sheet piles)



Section description	Product group	Shape	Section Modulus	Moment of Inertia	Width	Height	Thickness flange	Thickness web	Weight single	Weight	Coating 2 sides	Coating area
			in ³ /ft cm ³ /m	in ⁴ /ft cm ⁴ /m	inch mm	inch mm	inch mm	inch mm	lbs/ft kg/m	lbs/ft ² kg/m ²	ft ² /ft m ² /m	ft ² /ft m ² /m
PZ27	Hot rolled sheet piles	Z	30.2	184.2	18.00	12.00	0.375	0.375	40.5	27.00	4.48	1.49
			1,624	25,154	457	305	9.5	9.5	60.26	40.18	1.37	1.49

Production acc. ASTM standard or EN10248 1&2 in varies steel grades

Origin: USA

Datasheet for estimation and comparison purposes