

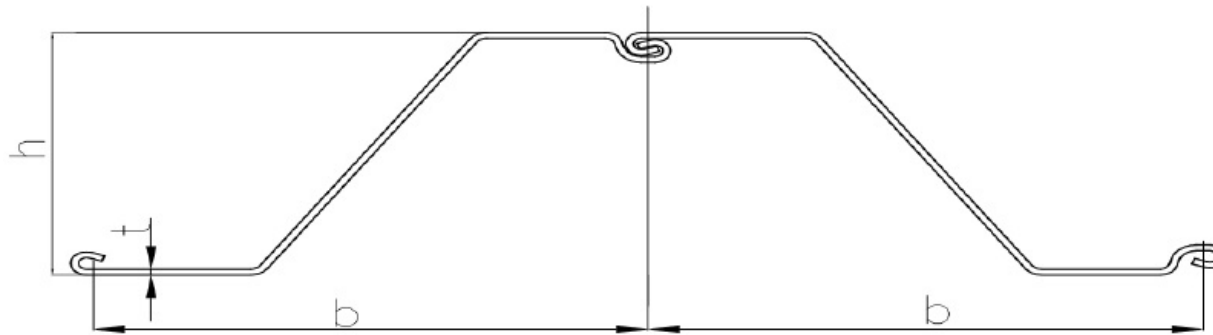

## SKZ 24 (Cold rolled sheet piles)



Section description	Product group	Shape	Section Modulus	Moment of Inertia	Width	Height	Thickness flange	Thickness web	Weight single	Weight	Coating 2 sides	Coating area
			in <sup>3</sup> /ft cm <sup>3</sup> /m	in <sup>4</sup> /ft cm <sup>4</sup> /m	inch mm	inch mm	inch mm	inch mm	lbs/ft kg/m	lbs/ft <sup>2</sup> kg/m <sup>2</sup>	ft <sup>2</sup> /ft m <sup>2</sup> /m	ft <sup>2</sup> /ft m <sup>2</sup> /m
SKZ 24	Cold rolled sheet piles	Z	37.7	301.8	28.50	16.00	0.375	0.375	57.4	24.18	7.60	1.60
			2,028	41,213	724	406	9.5	9.5	85.46	35.98	2.32	1.60

Production acc. ASTM standards or EN10249 1&2 in varies steel grades

Origin: USA

Datasheet for estimation and comparison purposes