

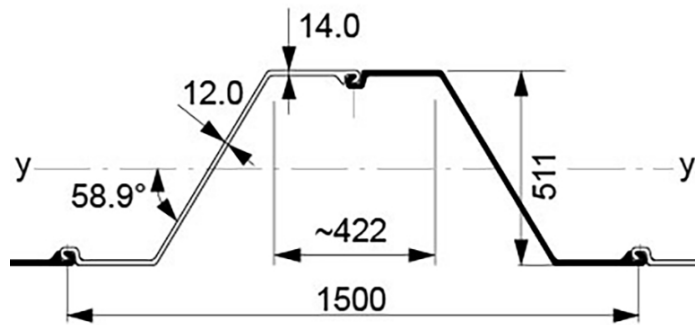

AZ 32-750 (Hot rolled sheet piles)



Section description	Product group	Shape	Section Modulus	Moment of Inertia	Width	Height	Thickness flange	Thickness web	Weight single	Weight	Coating 2 sides	Coating area
			in ³ /ft cm ³ /m	in ⁴ /ft cm ⁴ /m	inch mm	inch mm	inch mm	inch mm	lbs/ft kg/m	lbs/ft ² kg/m ²	ft ² /ft m ² /m	ft ² /ft m ² /m
AZ 32-750	Hot rolled sheet piles	Z	59.5	599.0	29.53	20.12	0.551	0.472	78.4	31.88	6.93	1.41
			3,199	81,798	750	511	14.0	12.0	116.72	47.44	2.12	1.41

Production acc. EN10248 1&2 in varies steel grades
 Origin: Luxembourg
 Datasheet for estimation and comparison purposes