

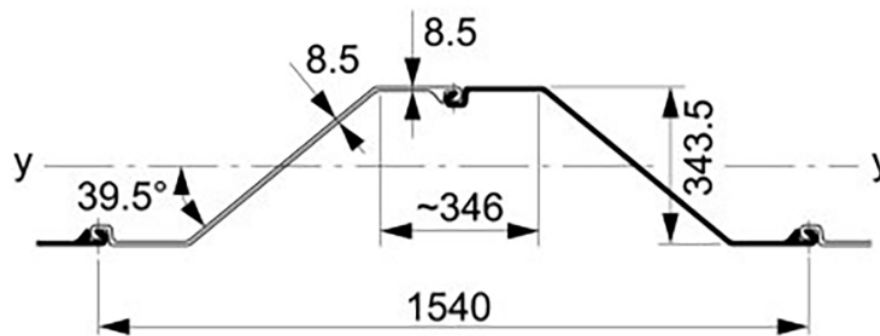

AZ12-770 (Hot rolled sheet piles)



Section description	Product group	Shape	Section Modulus	Moment of Inertia	Width	Height	Thickness flange	Thickness web	Weight single	Weight	Coating 2 sides	Coating area
			in ³ /ft cm ³ /m	in ⁴ /ft cm ⁴ /m	inch mm	inch mm	inch mm	inch mm	lbs/ft kg/m	lbs/ft ² kg/m ²	ft ² /ft m ² /m	ft ² /ft m ² /m
AZ12-770	Hot rolled sheet piles	Z	23.2	156.7	30.31	13.52	0.335	0.335	48.8	19.31	6.07	1.20
			1,247	21,397	770	343	8.5	8.5	72.58	28.73	1.85	1.20

Production acc. EN10248 1&2 in varies steel grades
 Origin: Luxembourg
 Datasheet for estimation and comparison purposes