

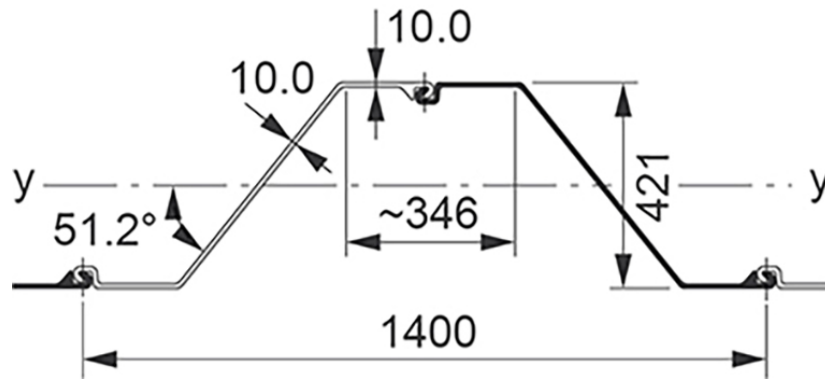

AZ20-700 (Hot rolled sheet piles)



Section description	Product group	Shape	Section Modulus	Moment of Inertia	Width	Height	Thickness flange	Thickness web	Weight single	Weight	Coating 2 sides	Coating area
			in ³ /ft cm ³ /m	in ⁴ /ft cm ⁴ /m	inch mm	inch mm	inch mm	inch mm	lbs/ft kg/m	lbs/ft ² kg/m ²	ft ² /ft m ² /m	ft ² /ft m ² /m
AZ20-700	Hot rolled sheet piles	Z	36.2	300.0	27.56	16.57	0.394	0.394	56.1	24.43	6.10	1.33
			1,946	40,967	700	421	10.0	10.0	83.49	36.35	1.86	1.33

Production acc. EN10248 1&2 in varies steel grades
Origin: Luxembourg
Datasheet for estimation and comparison purposes