

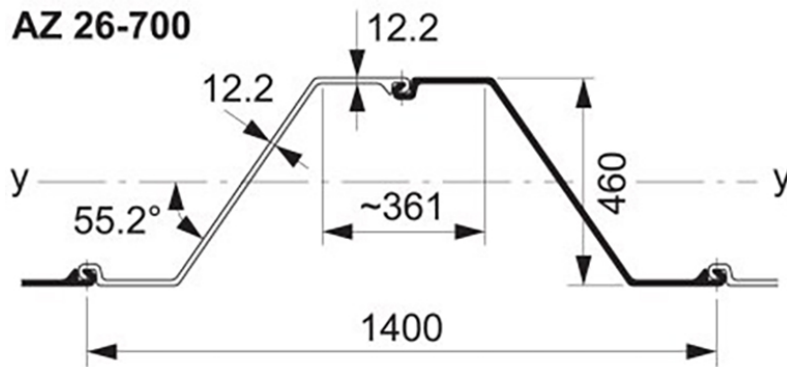

AZ26-700 (Hot rolled sheet piles)



Section description	Product group	Shape	Section Modulus	Moment of Inertia	Width	Height	Thickness flange	Thickness web	Weight single	Weight	Coating 2 sides	Coating area
			in ³ /ft cm ³ /m	in ⁴ /ft cm ⁴ /m	inch mm	inch mm	inch mm	inch mm	lbs/ft kg/m	lbs/ft ² kg/m ²	ft ² /ft m ² /m	ft ² /ft m ² /m
AZ26-700	Hot rolled sheet piles	Z	48.4	437.3	27.56	18.11	0.480	0.480	69.1	30.10	6.33	1.38
			2,602	59,717	700	460	12.2	12.2	102.85	44.79	1.93	1.38

Production acc. EN10248 1&2 in varies steel grades
 Origin: Luxembourg
 Datasheet for estimation and comparison purposes